



Global Innovators in Technology

# **Multi-Stage Dry Vacuum Pumps**

## **Installation — Operation — Maintenance**

### **Manual**

Pump Model 40x20

EBARA Technologies, Incorporated  
51 Main Avenue  
Sacramento, CA 95838  
(916) 920-5451; Fax: (916) 925-6654

**Copyright © 1993 by EBARA Technologies, Inc.**

## **To Our Customers**

Ebara Technologies, Inc., and its employees appreciate that you have selected an Ebara Vacuum Pump for your needs. Our pump is manufactured with a great deal of care and attention. This is to ensure the best performance, as well as safe and satisfactory operation; however, improper handling or operation could affect performance, and could result in accidents, causing injury to personnel.

This manual has been prepared to illustrate how to properly install, operate, and maintain the pump. A step-by-step guide is provided to make sure that the vacuum pump system is put into place in accordance with manufacturer's recommendations.

We take this opportunity to thank you for the purchase of this dry vacuum pump, which has been build and factory tested to meet the stringent Ebara quality and reliability standards.

**WARRANTY**  
**EBARA Technologies, Incorporated**

Products manufactured by Supplier are warranted against defects in materials and workmanship for 12 months from date of initial operation or 15 months from date of shipment by Supplier, whichever occur first. Supplier's liability under valid warranty claims is limited, at the option of Supplier, to repair, replacement, or refund of an equitable portion of the purchase price of the Product. Items expendable in normal use are not covered by this warranty. All warranty replacement or repair of parts shall be limited to equipment malfunctions which, in the sole opinion of Supplier, are due or traceable to defects in original materials or workmanship. All obligations of Supplier under this warranty shall cease in the event of abuse or accident. Parts are warranted only for the remaining unexpected portion of the original warranty period applicable to the parts repaired or replaced. After expiration of the applicable warranty period, Customer shall be charged at the then current prices for parts, labor and transportation.

Supplier assumes no responsibilities for damages caused by improper installation or by operation in violation of the equipment's rated operation condition, internal or otherwise, or by improper handling or maintenance.

The Supplier is not liable for any special, indirect, incidental, or consequential damage.

Warranties given by vendors of equipment or proprietary components not manufactured by Supplier but incorporated by Supplier into its Products shall be passed on to Customer; provided that in no event shall Supplier have any liability for failure of such vendor to perform on its warranty.

Except as stated herein, **Supplier makes no warranty of merchantability or fitness for purpose, express or implied (either in fact or by operation of law), statutory or otherwise;** and, except as stated herein, Supplier shall have no liability under any warranty, express or implied (either in fact or by operation of law), statutory or otherwise. Statements made by any person, including representatives of Supplier, which are inconsistent or in conflict with the terms of this warranty shall not be binding upon Supplier unless specified in writing and approved by an officer of Supplier.

## **WARRANTY (con't)**

All claims under warranty must be made promptly after occurrence of circumstances giving rise thereto, and must be received within the applicable warranty period by Supplier or its authorized representative. Such claims should include Product serial number, the date of shipment, and a full description of the circumstances giving rise to the claim. Before any Products are returned for repair and /or adjustment, written authorization from Supplier or its authorized representative for the return and instructions as to how and where these Products should be returned must be obtained. Any Product returned to Supplier for examination shall be sent prepaid via the recommended means of transportation. Claims may be denied on items not promptly reported and on any warranty claim on any item that has been altered or has been returned for examination and inspection, or for any other reason, Customer shall be responsible for all damage resulting from improper packing or handling, and for loss in transit, notwithstanding any defect or nonconformity in the Product. In all cases Supplier has responsibility for determining the cause and nature of failure, and Supplier's determination with regard thereto shall be final.

If it is found that Supplier's Product has been returned without cause and is still serviceable, Customer will be notified and the Product returned at Customer's expense; in addition, a charge for testing and examination may be made on Products so returned.

No allowance shall be made for repairs or alterations made by others without the Supplier's written consent or approval. If repairs or alterations are attempted without the Supplier's consent, the Supplier's warranty is void.

If in the Supplier's opinion, repairs have to be effected at the Customer's plant site, local labor shall be placed at the disposal of the Supplier's representative by the Customer, free of charge to the Supplier. It may also be necessary to supply lifting and hoisting equipment of sufficient capacity upon request of the Supplier's representative, at no cost to Supplier.

Defective parts replaced by the Supplier become the property of the Supplier.

Preventive maintenance shall be performed by Customer at regular intervals dependent on process severity and hours of operation.

**Record of changes**

<b>Rev.</b>	<b>Date</b>	<b>Page</b>	<b>Position</b>	<b>Contents</b>	<b>Reason</b>
A	12/12/97				New Release per ECO 2905

1.0	Safety.....	1
1.1	User Obligations to Safety .....	1
1.1.1	Electrical Grounding.....	1
1.1.2	Exhaust Venting.....	1
1.2	Safety Labels .....	1
1.3	Hazard Icons .....	2
2.0	Product Overview.....	5
2.1	Summary of Requirements.....	5
2.1.1	Nitrogen Flow.....	5
2.1.2	Cooling Water.....	5
2.1.3	Lubricating Fluid.....	5
2.1.4	Pump Overhaul .....	7
2.2	40x20.....	8
2.2.1	40x20 Specifications .....	8
2.2.2	40x20, Side View.....	9
2.2.3	40x20, Gear End .....	10
2.2.4	40x20, Motor End.....	11
2.2.5	40x20, Top View .....	12
2.2.6	40x20 w/Coolers, Side View .....	13
2.2.7	40x20 w/Coolers, Gear End.....	14
2.2.8	40x20 w/Coolers, Motor End .....	15
3.0	Installation.....	16
3.1	Unpacking and Initial Positioning .....	16
3.1.1	Pump Location .....	16
3.1.2	Leveling Pads.....	16
3.1.3	Lubricating Fluid Reservoirs .....	16
3.2	Vacuum Piping .....	17
3.3	Water Piping .....	17
3.3.1	Cooling Water Requirements: .....	18
3.4	Nitrogen Purge Piping .....	18
3.4.1	Nitrogen Supply Requirements.....	18
3.5	Electrical Connections .....	19
3.5.1	Control Panel.....	19
3.6	Initial Check.....	20
4.0	Operation .....	21
4.1	Safety Issues.....	21
4.2	Pre-Start Check.....	21
4.2.1	Initial Positioning .....	21
4.2.2	Lubricating Fluid Reservoirs .....	21
4.2.3	Vacuum Piping .....	21
4.2.4	Cooling Water.....	22
4.2.5	Nitrogen Purge .....	22
4.3	Start-Up & Trial Run .....	22
4.4	Auto Mode.....	23

4.5	Manual Operation.....	23
5.0	Pump Maintenance .....	24
5.1	Safety Issues.....	24
5.2	Weekly Maintenance.....	24
5.3	Other Periodic Maintenance .....	25
5.3.1	Lubricating Fluid Change .....	25
5.3.2	Complete Pump Overhaul .....	25
5.4	Lubricating Fluid Level.....	25
5.4.1	Checking the Lubricating Fluid Level.....	26
5.4.2	Sight Glass Locations .....	26
5.4.3	Checking for Discoloration.....	26
5.4.4	Refilling or Replacing the Lubricating Fluid.....	27
5.4.5	Changing the Lubricating Fluid.....	27
5.4.6	Replenishing the Lubricating Fluid .....	29
5.4.7	Cleaning the Sight Glass.....	29
5.5	Vibrations and Noise .....	30
5.6	Motor Current.....	31
5.7	Nitrogen Purge Flow.....	31
5.7.1	Nitrogen Supply Requirements .....	32
5.8	Cooling Water Flow Rate .....	32
5.8.1	Cooling Water Requirements .....	32
5.9	Ultimate Pressure.....	32
5.10	Cooler Inspection and Cleaning .....	33
5.10.1	Overview.....	33
5.10.2	Single Pass Cooler Inspection Procedure .....	35
5.10.3	Single Pass Cooler Cleaning Procedure .....	37
5.11	Leak-Checking the Pump.....	41
5.12	Consumables and Spares List .....	42
6.0	Troubleshooting.....	43
6.1	Possible Problems / Suggested Solutions.....	43
6.2	Service Centers.....	46
6.2.1	USA .....	46
6.2.2	EUROPE .....	47
6.2.3	ASIA/PACIFIC RIM .....	47
7.0	Attachments.....	49



## 1.0 Safety

General safety guidelines:

- Always comply with all safety labels and hazard icons.
- Never disable any interlocks.
- Never take short-cuts.
- Only qualified personnel should be allowed to operate or perform maintenance on this equipment.

### 1.1 User Obligations to Safety

This equipment is designed with safety features to protect operators and service personnel from harm and to protect the equipment from damage. It is important that the customer ensure that all safety procedures are followed and that all safety features are maintained in proper operating condition. It is the user's responsibility to operate all equipment according to the recommended procedures, and to maintain safe operating conditions at all times. Ebara Technologies, Inc., assumes no liability for personal injury or for damage to equipment resulting from the improper operation or service of the equipment.

#### 1.1.1 Electrical Grounding

All electrical connections must be properly grounded in accordance with equipment specifications and in compliance with all applicable codes and ordinances.

#### 1.1.2 Exhaust Venting

The customer is responsible for the proper venting of equipment exhaust systems in compliance with all applicable codes and ordinances.

### 1.2 Safety Labels

Safety labels and hazard icons appear throughout this manual and on the equipment itself. Their purpose is to alert personnel to areas requiring specific attention. The information contained in the following sections is a summary of the related safety labels and hazard icons.

Personnel should be alert to four safety labels. They are identified by the following symbols:

#### Danger Label



Danger labels signify potentially lethal situations. They are generally used when failure to observe instructions or precautions could result in death. Potential exposure to high electrical current or to poisonous gases are examples of where a Danger label would appear.

#### Warning Label

 **WARNING**

Warning notices signify situations involving potential bodily injury. They are generally used when failure to observe instructions or precautions could result in severe injury or, possibly, death. Potential exposure to extreme heat or cold, or mechanical dangers are examples of where a Warning label would appear.

**Caution Label** **CAUTION**

Caution notices signify situations where failure to observe instructions or precautions could result in significant damage to equipment or facilities. Potential damage due to failure to maintain proper oil level is an example of where a Caution label would appear.

**Safety Instructions****SAFETY  
INSTRUCTIONS**

Safety Instruction notices provide specific instructions about avoiding or preventing a hazardous situation. They give information about safety precautions to be taken, or special equipment needed, to accomplish the task safely. Safety Instructions are normally preceded with a Danger, Warning, or Caution label.

### 1.3 Hazard Icons

The following are examples of the hazard icons used throughout this manual.

**Electric Shock**

This icon indicates potential electrical shock. Danger indicates that potential loss of life could occur.

**High Pressure**

This icon indicates potential harm from a release of high pressure. Warning indicates that severe injury could occur.

## Toxic Fumes

**! DANGER**



This icon indicates the possible presence of toxic fumes, gasses, or particles. Danger indicates that potential loss of life could occur.

## Explosion

**! WARNING**



This icon indicates potential harm from explosion. Warning indicates that severe injury could occur.

## Extreme Heat

**! WARNING**



This icon indicates potential harm due to extreme heat. Warning indicates that severe injury could occur.

## Mechanical Damage

**! CAUTION**



This icon indicates potential mechanical damage. Caution indicates that damage to equipment or facilities could occur.

## Flying Particles

**! WARNING**



This icon indicates potential hazard from flying particles and that safety glasses should be worn. Warning indicates that severe injury could occur.

## Caustic Chemicals

**! WARNING**



This icon indicates potential hazard caustic chemicals. Warning indicates that severe injury could occur.



## 2.0 Product Overview

### NOTICE

The descriptions and instructions included in this manual are for a typical pump installation. Documentation specific to this pump installation has been included in the Attachments section. This section is located at the back of the manual. Please refer to the Attachments section for installation-specific information *before* attempting to operate this system.

### NOTICE

The entire manual should be reviewed thoroughly before operating the pump. This section is presented as an overview only. This section is not meant as a substitute for the other sections of this manual.

## 2.1 Summary of Requirements

### 2.1.1 Nitrogen Flow

Nitrogen flow serves two purposes: (1) sealing and (2) dilution. Needle valves are preset at the factory and should not be adjusted.

General Settings: Flow meter wide open. Flow will stabilize around 5-8 lpm.

### 2.1.2 Cooling Water

The purpose of the cooling water is to cool motors, gears, and gas coolers (interstage coolers). Pressure must be less than 4 kgf/cm<sup>2</sup> (60 psi). The required differential pressure across the cooling water inlet-to-outlet is 1-2 kgf/cm<sup>2</sup> (14-28 psi). The required flow rate is 5-8 lpm. Only 1 lpm of the total 5-8 lpm flow is diverted to the intercoolers. The reason for this is to prevent chemical build-up in the coolers due to excessive cooling.

If the cooling water is restricted for any length of time with the pump(s) running, the rear pumps could overheat and seize. All pumps are designed to shut down if the cooling water flow drops below 3-4 lpm (after a 3-minute time delay). Normal operating temperature is process and pump condition dependent.

### 2.1.3 Lubricating Fluid

Ebara dry pumps use only perfluorinated polyether (PFPE) fluid to lubricate the pump's bearings and gears. This fluid is non-flammable and inert. This is the lubricating fluid referred to throughout the manual.

**CAUTION**

It is very important that the lubricating fluid is maintained at the proper level. Failure to do so could result in severe damage to the pump.

**CAUTION**

When changing or replenishing lubricating fluid, be sure to stop the pump and allow the pump to return to atmospheric pressure. Because the lubricating fluid reservoir is under vacuum, the pump can be severely damaged if the lubricating fluid port is removed while the pump is in operation, or not at atmosphere.

**CAUTION**

Before attempting to add any lubricating fluid into the pump, it is imperative that the secondary reservoirs are drained first. Failure to do so could result in lubricating fluid being forced into the vacuum area of the pump.

**NOTICE**

Use Krytox 1525, Fomblin Y-LVAC 25/6, Barrierta J100.

Previously specified Krytox 1514, Fomblin Y-LVAC 16/6, Barrierta J60 may be used if supplied with pump.

There are four lubricating fluid reservoirs on each pump module: Two primary, and two secondary reservoirs. A secondary lubricating fluid reservoir is provided for each pump for each primary lubricating fluid reservoir. Over a period of time, a small amount of lubricating fluid may migrate from the primary to the secondary reservoirs.

All primary reservoirs must be filled to the upper limit line in the sight glass. Do not overfill. All secondary reservoirs should always be drained before lubricating fluid is added or changed in the primary reservoirs. **The pump must be off and at atmosphere before lubricating fluid can be added or changed.** If lubricating fluid is not drained from the secondary reservoirs, lubricating fluid could eventually be forced into the vacuum chamber of the pump.

Occasionally process gasses may discolor the lubricating fluid sight glass, making it difficult to read lubricating fluid levels. The sight glass can be removed and cleaned whenever the lubricating fluid is being changed.

### **2.1.4 Pump Overhaul**

Depending on the process, a complete pump overhaul is recommended every 1-2 years as a means of ensuring trouble-free performance. During overhaul service, all bearings, labyrinth seal rings, and O-rings are replaced; coolers are cleaned or exchanged, and the pump internals area cleaned, wet bead finished and vacuum baked. The overhaul requires 1-2 weeks to complete, not including shipping to and from the service center. Exchange pumps are available upon request. Contact your Ebara representative for further details.

## 2.2 40x20

This pump consists of one pump module: A five-stage rotary vacuum pump.  
Ultimate pressure:  $3 \times 10^{-2}$  Torr.

### 2.2.1 40x20 Specifications

SPECIFICATIONS FOR <b>EBARA</b> MULTI-STAGE DRY PUMP			
<b>MODEL 40X20 ERD5M</b>		<b>60 Hz</b>	<b>50 Hz</b>
<b>PUMP SPEED</b>		1200 LPM 42 CFM	1000 LPM 35 CFM
<b>ULTIMATE PRESSURE</b>		$3 \times 10^{-2}$ Torr	$4 \times 10^{-2}$ Torr
<b>M O T O R</b>	POWER	2.2 kW	
	CURRENT FULL LOAD	2.2 kW	2.2 kW
	VOLTAGE	208 VAC	200 VAC
	RPM	3460	2880
<b>FLANGING</b>	INLET	KF 40	
	EXHAUST	KF 20	
<b>W A T E R C O O L I N G</b>	INLET	3/8" NPT Female	
	OUTLET	3/8" NPT Female	
	PRESSURE	< 4 kgf/cm <sup>2</sup> (60 psi) Differential: 1-2 kgf/cm <sup>2</sup> (14-28 psi)	
	QUANTITY	5 to 8 lpm (1.3 - 2.1 gpm)	
<b>N 2 P U R G E</b>	INLET	1/4" Tube Connection	
	PRESSURE PRIMARY: SECONDARY:	1-7 kgf/cm <sup>2</sup> (14-100 psi) 1 kgf/cm <sup>2</sup> (14 psi)	
	QUANTITY	5 to 8 slpm (0.2 - 0.3 cfm) w/o Exhaust Dilution	
<b>OIL QUANTITY</b>		0.4 L (13.5 oz.)	
<b>WEIGHT APPROXIMATE</b>		200 kg (440 lbs)	
<b>REMARKS:</b>			
<b>EBARA TECHNOLOGIES, INC.</b>			



### 2.2.2 40x20, Side View

Typical Configuration – Refer to Attachments for Specific Information.

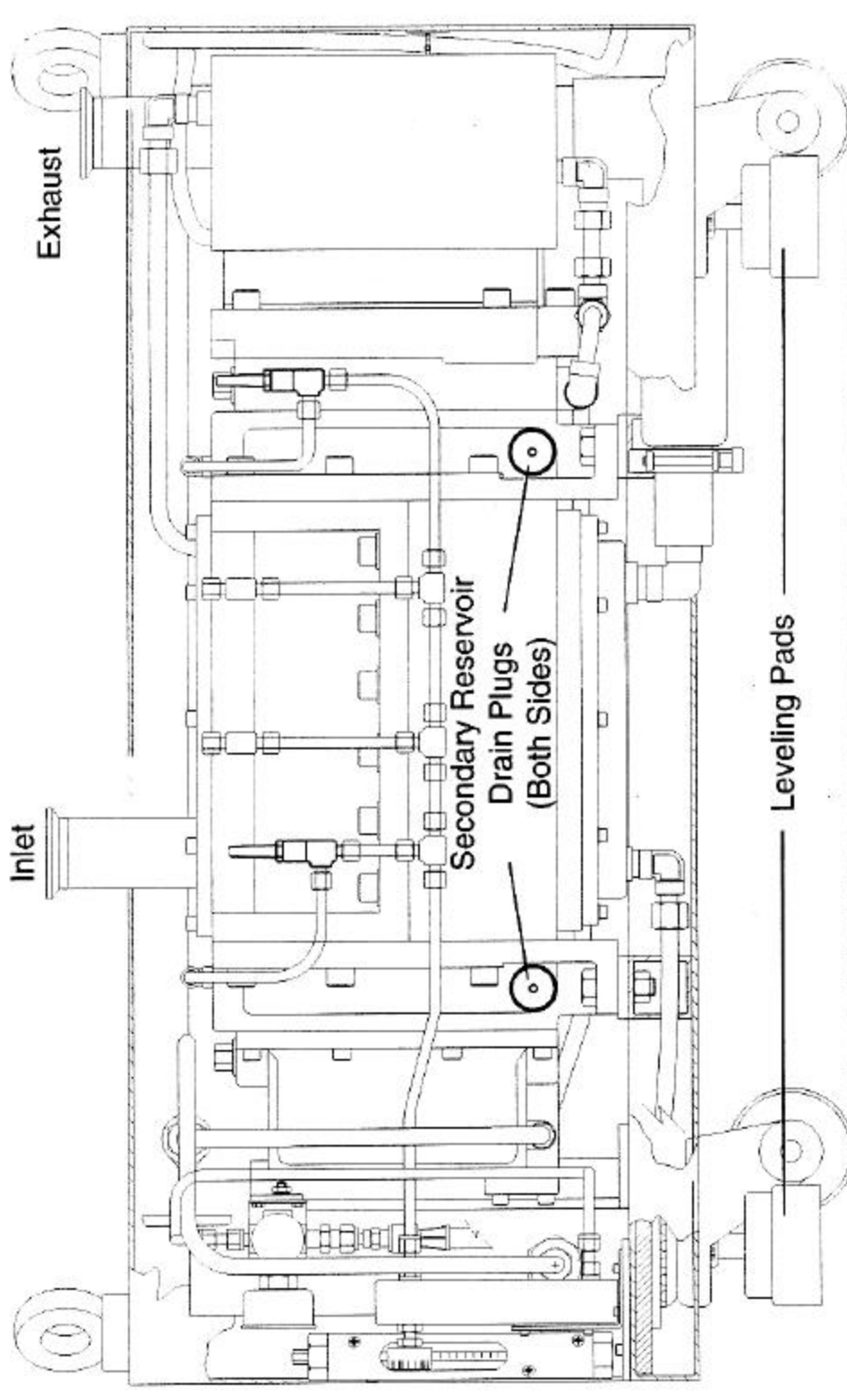

### 2.2.3 40x20, Gear End

Typical Configuration – Refer to Attachments for Specific Information.

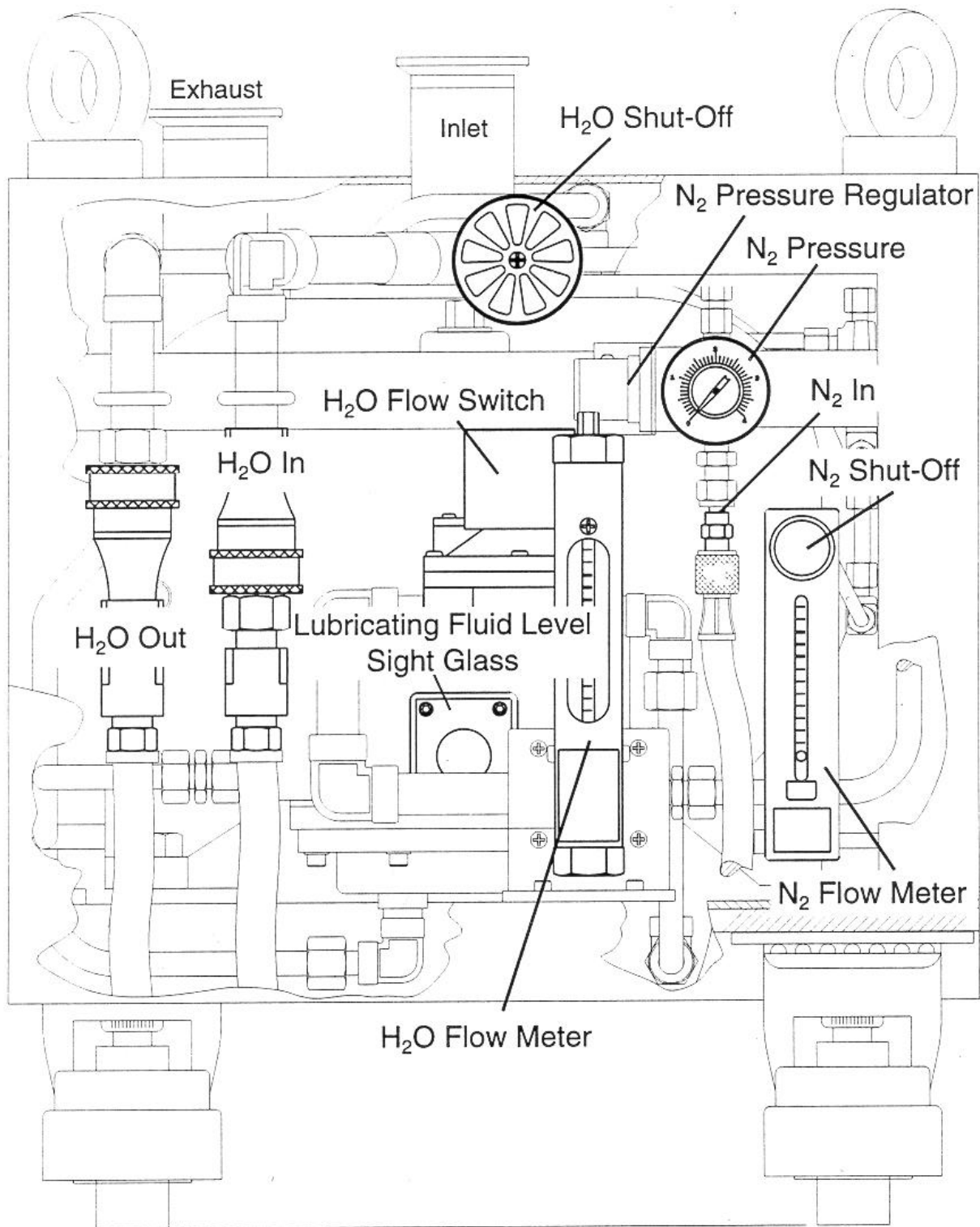

**2.2.4 40x20, Motor End**

Typical Configuration – Refer to Attachments for Specific Information.

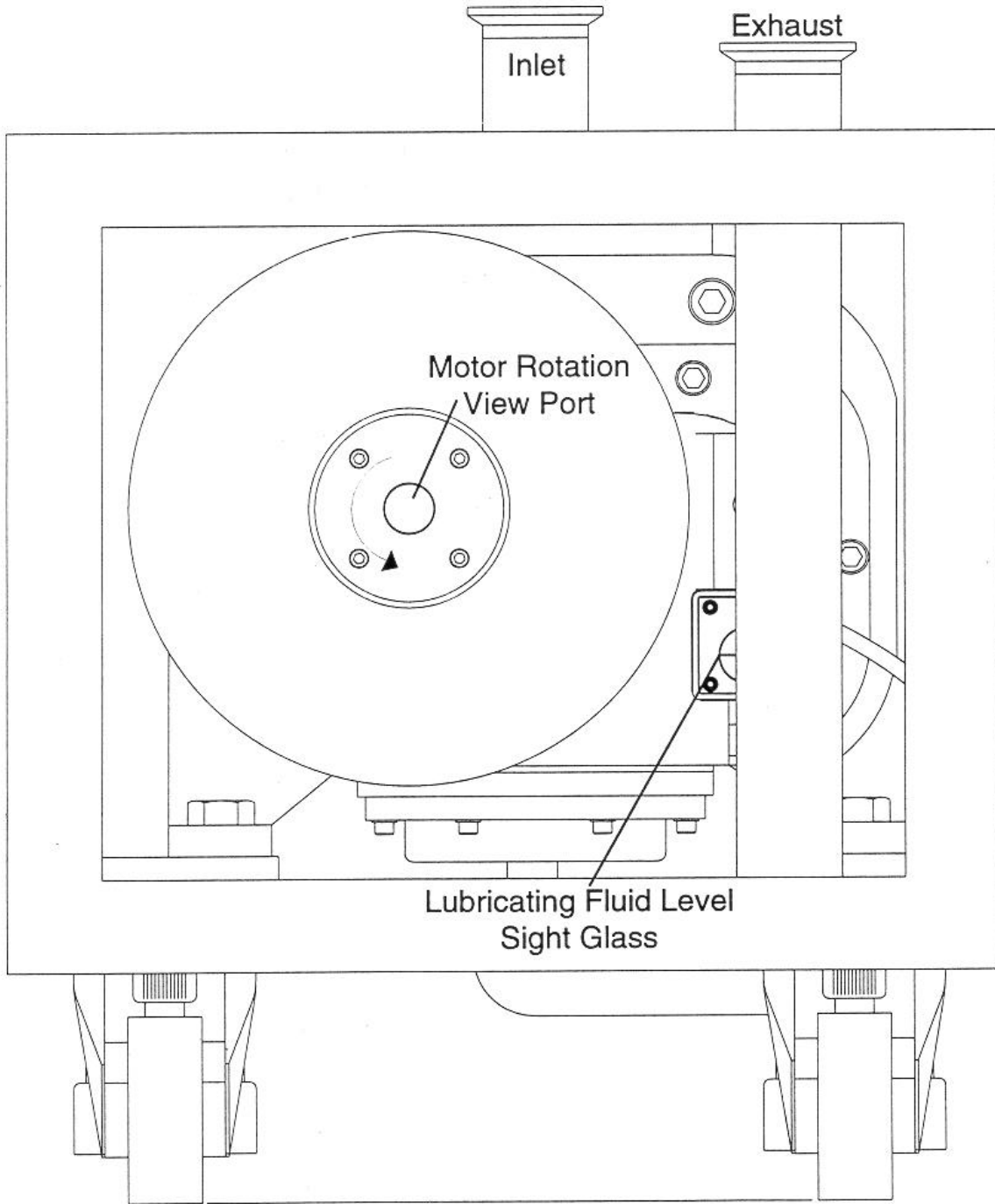

### 2.2.5 40x20, Top View

Typical Configuration – Refer to Attachments for Specific Information.

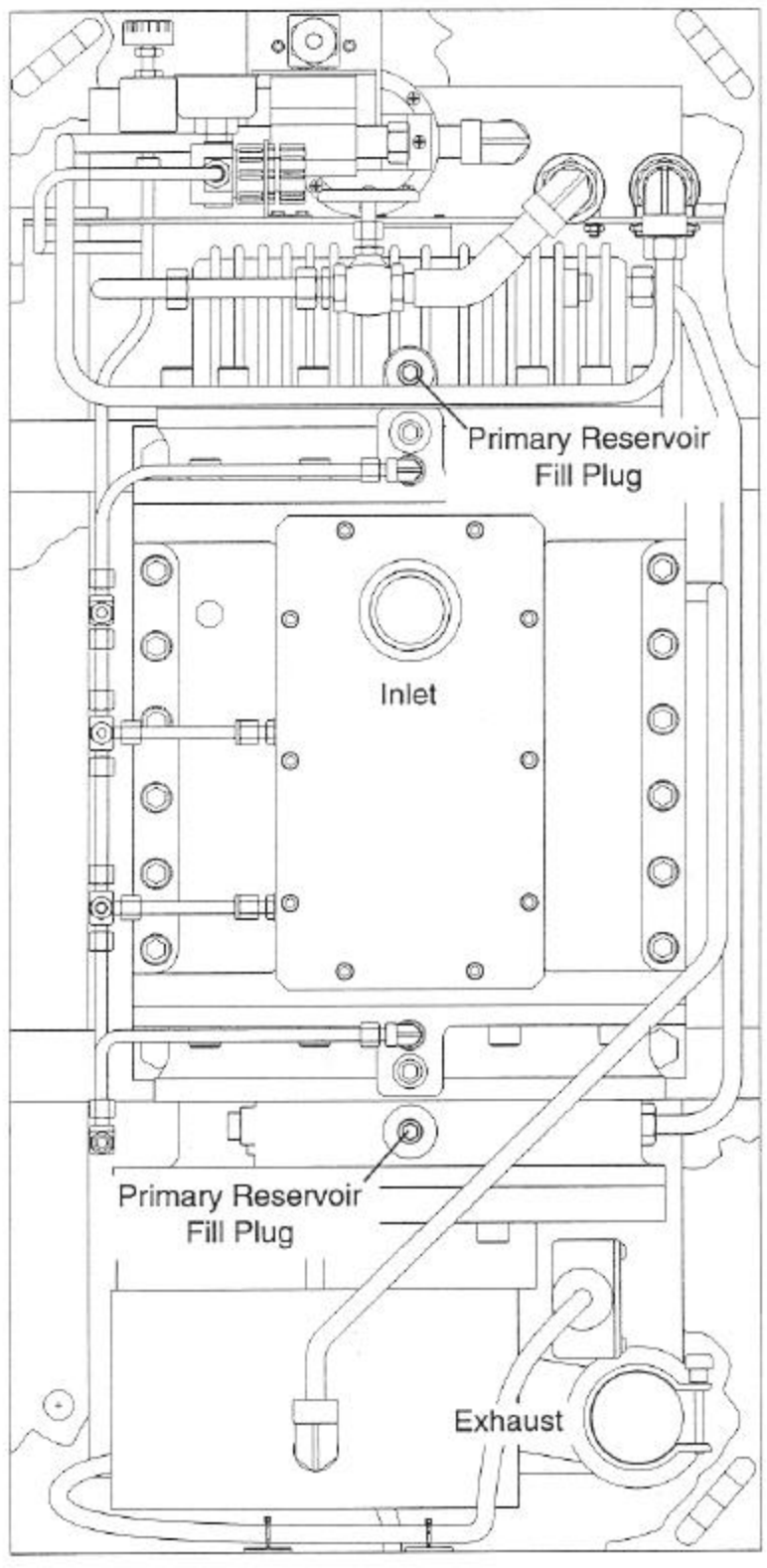

### 2.2.6 40x20 w/Coolers, Side View

Typical Configuration – Refer to Attachments for Specific Information.

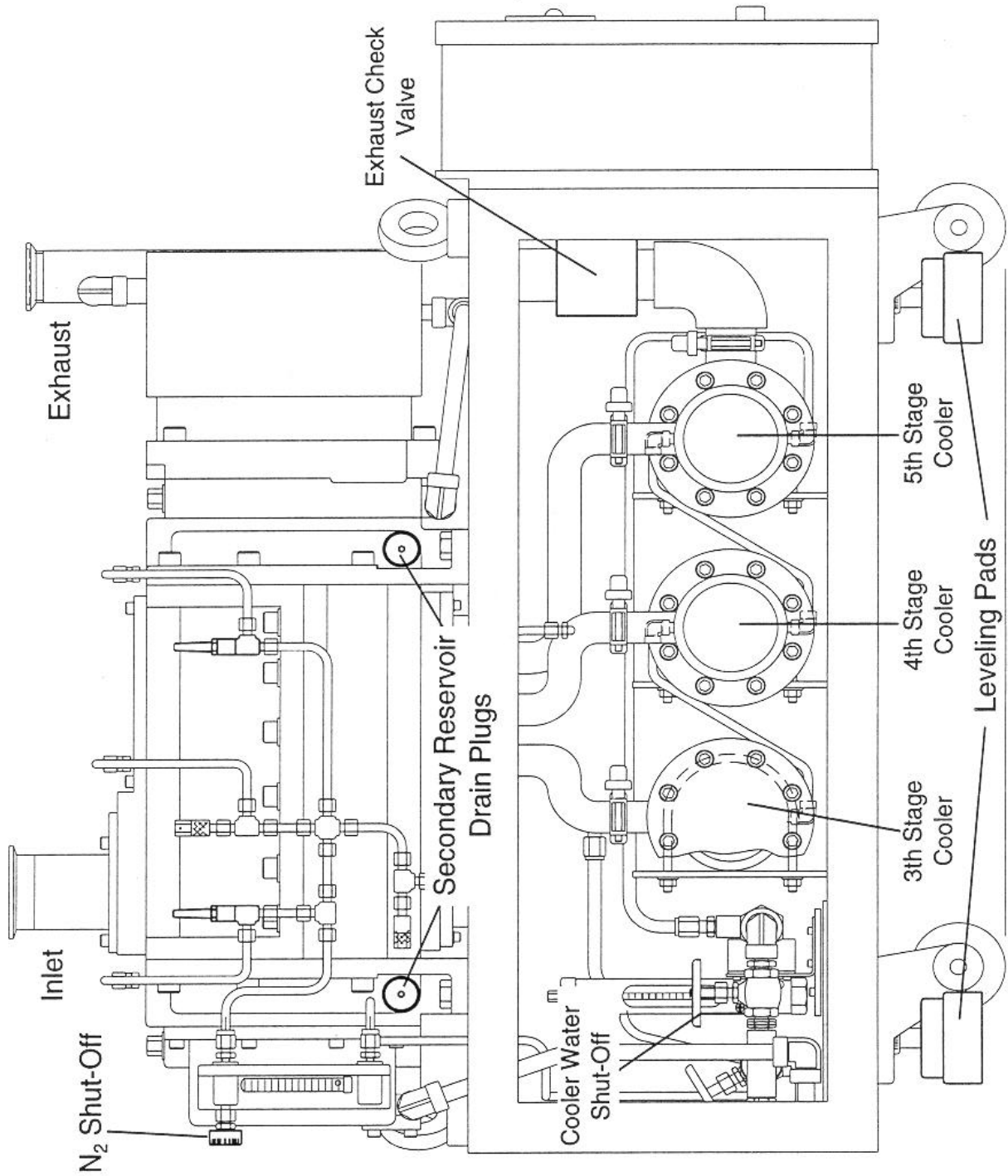

**2.2.7 40x20 w/Coolers, Gear End**

Typical Configuration – Refer to Attachments for Specific Information.

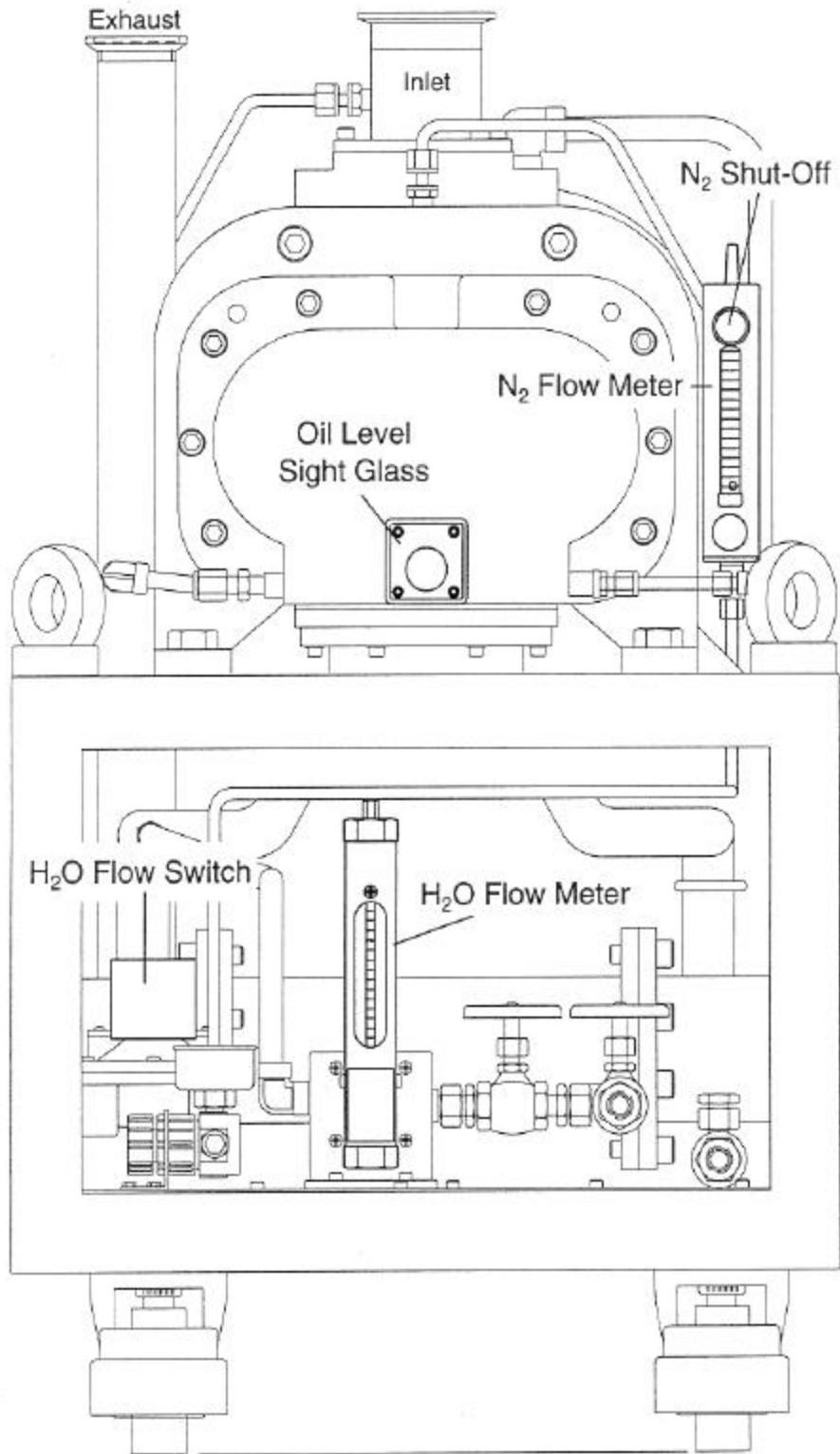

### 2.2.8 40x20 w/Coolers, Motor End

Typical Configuration – Refer to Attachments for Specific Information.

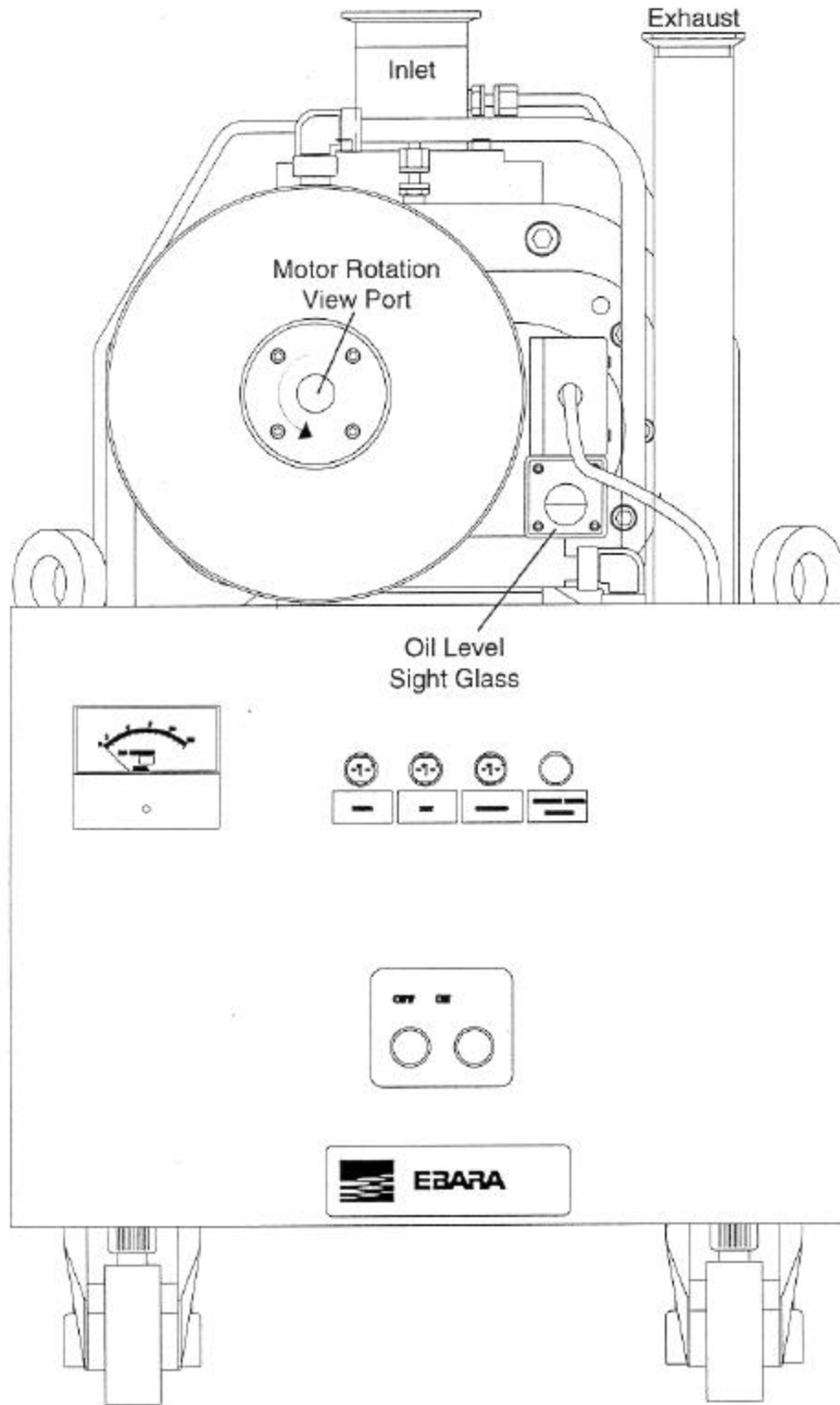

## 3.0 Installation

### NOTICE

The descriptions and instructions included in this manual are for a typical pump installation. Documentation specific to this pump installation has been included in the Attachments section. This section is located at the back of this manual. Please refer to the Attachments section for installation-specific information.

### 3.1 Unpacking and Initial Positioning

- Carefully unpack the pump.
- Check for signs of possible damage in shipment.
- Notify the Ebara representative immediately if there are any signs of damage.

#### 3.1.1 Pump Location

Locate the pump in an area that is:

- Free from excessive dust and moisture.
- Easily accessible to allow the pump to be serviced.
- Less than 40°C/104°F ambient temperature

#### 3.1.2 Leveling Pads

- Extend the leveling pads and level the pump.

Each castor includes an adjustable pad that extends, making the pump immobile. Adjust the pads to level the pump.

The pump must level. The castor provides an adjustment range of about 15 mm.

#### 3.1.3 Lubricating Fluid Reservoirs



**Be sure to use the outer most fill plugs. On all pump models, a second plug is located on the inner flange. This is not a fill plug and should not be removed to add lubricating fluid to the pump.**

- Fill the lubricating fluid reservoirs to the upper line on the motor sight glass (approximately .2 liters per reservoir). **Do not overfill.**

The lubricating fluid reservoirs are located at both ends of each pump. The lubricating fluid fill plugs are located on the top of the gear case and on the motor mounting flange.



**! NOTICE**

Recommended lubricating fluids for Ebara pumps are Krytox 1525, Fomblin Y-LVAC 25/6, Barrierta J100, or equivalent fluids.

### 3.2 Vacuum Piping

**! CAUTION**

Because of the pump's tight internal running clearances, care must be taken to prevent any foreign particles from entering the pump.

- Always cover the inlet of the pump when it is not connected to the vacuum piping. This is to prevent the entry of any foreign materials.
- Completely remove any welding scale or rust from the inside of all vacuum piping.
- Make sure that no particulate matter is present inside the vacuum vessel.
- Properly support all vacuum piping. This minimizes loads on the pump inlet and outlet flanges.
- Use of flexible bellows between the pump and the tool pump line will further minimize the transmission of vibrations.
- Use of a screen filter before the pump inlet is recommended. Contact your Ebara representative for more information.

### 3.3 Water Piping

A constant supply of water is required to cool the motors and pump module. If the cooling water is restricted for any length of time with the pump running, the pump could overheat and seize. All pumps are designed to shut down if the cooling water flow drops below 3-4 lpm (after a 3-minute time delay).

To confirm the water flow shut-off setting:

1. Open the control panel.
2. Gradually reducing the flow of cooling water until the LED on the delay timer comes on.
3. When the light comes on, stop reducing the flow and check the flow meter for the actual flow.
4. Check this value against the setting. Adjust the as needed, and recheck again by reducing the flow until the LED comes on.



**Use industrial water for cooling. The use of de-ionized water may cause corrosion of the pump internal parts. If de-ionized water is used, stainless steel plumbing is required. Use of a filter before the pump inlet is recommended. If the ambient temperature is expected to drop below freezing, and the pumps are not expected to be run, blow out all water from the pumps with compressed air.**

### 3.3.1 Cooling Water Requirements:

Flow:	Motor and module:	5.0-8.0 lpm	1.3-2.1 gpm
	Gas coolers:	0.8-1.2 lpm	0.21-0.32 gpm
Water flow less than 1 liter per minute to coolers will cause cooler corrosion.			
Pressure (Operating)		<4 kgf/cm <sup>2</sup>	60 psi
Inlet - Outlet Differential		1.0-2.0 kgf/cm <sup>2</sup>	14-28 psi
Temperature (max)		30°C	86°F
Connections:		3/8: NPT Female	
		(See "40x20 Specifications".)	

## 3.4 Nitrogen Purge Piping

A Nitrogen gas purge is used for labyrinth seal purge and gas dilution. The flow rates to the individual stages have been preset at Ebara by factory personnel and should not be adjusted in the field.

### 3.4.1 Nitrogen Supply Requirements

Supply Pressure:	1.0-7.0 kgf/cm <sup>2</sup>	14-100 psi
Regulated Pressure:	.9-1.1 kgf/cm <sup>2</sup>	14-21 psi
Connections:	1/4 inch tube	

Flow: 5.0 - 8.0 lpm .2 - .3 cfm  
 Excluding exhaust gas dilution, if applicable. (Process & Pump Specific. See Attachments in the back of the book.)

## 3.5 Electrical Connections



**All Equipment must be properly grounded.**

**Before attempting any repairs or adjustments to this equipment, be sure that the power to the unit is disconnected.**

**The electrical installation should only be undertaken by properly trained personnel.**

- All electrical installations should be in accordance with local regulations, the National Electric Code, and all other applicable codes and ordinances.
- All connections to and from the electrical supply must be with suitable connectors.

### 3.5.1 Control Panel

**Typical Description – varies with each pump installation.**

The control panel is the main interface between the pump modules and in-house system and electrical connections. The control panel contains relays and controls that monitor the cooling water and nitrogen purge flow. Also available are outputs signals from each of these controls for remote monitoring.

The standard Ebara control panels are for 208 volt, 3-phase, 4-wire service. A main circuit breaker receives the incoming power conductors and provides over current protection. The power to each motor is controlled by a contactor. An overload relay, mounted to the contactor, senses when the motor is overloaded or when there is a motor phase imbalance. When the rear pump overload relay (OL1) trips, the pump stops. An ammeter for each motor is mounted on the cabinet door. This allows the user to monitor the motor current.

Overload contactors–relays: MS1–OL1.

When cooling water flow is not sufficient, the water flow switch opens, dropping out relay 69X1. A NC 69X1 contact closes, which energizes 69T, a 3-minute timer. If the water flow is still not restored in this time, 69T times out. This stops the pump motor.

There are indicator lights on the control panel for the following conditions:

AC power supplied to the unit

Pump running

Pump overload

Fore pump overload

Low cooling water

There are two signals available that can be used on the customer's control system. These are relay contacts and are connected to the following terminals:

C1-C-2 Fore Pump Running (Closed when running)

C1-C3 Cooling Water Failure (Open when water failure)

The pump may be started either locally (Manual) or remotely (Auto). The Auto/Manual switch is located inside the control panel. In Manual mode, the pump is started and stopped by pressing the ON or OFF buttons on the front of the control panel. In the auto mode, power from a remote source is supplied to terminals B1 and B2. This energizes the 1X relay, which allows the pump to run. Or, a relay contact can be connected to terminals D1 and D2. When the relay contact is closed, the pump will run; when the relay contact is open, the pump will stop.

### 3.6 Initial Check

- Check the cooling water and nitrogen flows for correct settings.
- Check that the primary lubricating fluid reservoirs have been filled with lubricating fluid (to the upper limit line).
- Blank off the inlet.
- Turn the power to the system on.
- Momentarily start each pump to verify correct direction of rotation (counter-clockwise when viewed from the motor end).

If the direction of rotation is incorrect, the position of any two of the three power supply conductors must be reversed.

## 4.0 Operation

### 4.1 Safety Issues



If any toxic and pyrophoric gasses are used, it is necessary to maintain a flow of dilution Nitrogen to the dry pump. Failure to do so could result in fire or explosion. Ebara dry pumps are equipped with provisions for diluting exhaust gasses, and for purging seals and gear chambers with Nitrogen.

### 4.2 Pre-Start Check



The descriptions and instructions included in this manual are for a typical pump installation. Documentation specific to this pump installation has been included in the Attachments section. This section is located at the back of this manual. Please refer to the Attachments section for installation-specific information.

#### 4.2.1 Initial Positioning

- Shipping hardware repositioned.
- Suitable location for the pump.
- The pump is secure, level; the leveling pads are properly adjusted.

See "Pump Location".

#### 4.2.2 Lubricating Fluid Reservoirs

- Ensure that all primary lubricating fluid reservoirs are filled to the upper limit line.
- See "Lubricating Fluid Reservoirs".

#### 4.2.3 Vacuum Piping

- Ensure that all vacuum fittings are tight and that the piping is supported properly,

where necessary.  
See "Vacuum Piping".

#### 4.2.4 Cooling Water

Turn on the water flow and check for proper flow and pressure.

- Check for any leaks.
- If equipped, set cooling flow through the coolers at 1 lpm.\*\*\*
- Set total cooling water flow through the pump at 5-8 lpm.\*\*\*

\*\*\*These are interactive adjustments: adjusting one will affect the other. Be sure to recheck both settings when making adjustments.

See "Cooling Water Requirements".

#### 4.2.5 Nitrogen Purge

Turn on the Nitrogen flow and check for proper flow and pressure.

- Set the pressure regulators on the pump to 1 kg/cm<sup>2</sup> (14.2 psi).
- Open the flow meter control valve to wide open. Check for proper flow. Some pumps are equipped with two Nitrogen flow meters. One meter is for the pump module. The other meter is for exhaust gas dilution and is process dependent.

See "Nitrogen Supply Requirements".

### 4.3 Start-Up & Trial Run



**It is preferred that the initial startup be performed by Ebara service personnel or their authorized representative.**

Proceed with the following only after having completed the Prestart Check.

1. Open all exhaust valves.
2. Close all inlet valves.
3. Energize the control panel: turn on the power at the main breaker.
4. Set the Auto/Manual switch to Manual to control the pump from the control panel.
5. Momentarily "bump" the pump to check for proper motor rotation.

See "Initial Check"

6. Turn the pump on.

After 30 minutes of operation:

7. Record the base pressure. \_\_\_\_\_

This is the initial operating base pressure. Compare this with the pump specification (See "40x20 Specifications".) If the pump fails to reach the spec. In the 30 minutes of operation, allow another 30 minutes and recheck the pressure. If the pump still fails to reach the spec., contact your Ebara Service Center. (See "Service Centers".)

8. Record the running motor current for the pump. \_\_\_\_\_

This is the initial operation running motor current. Compare this with the following chart to ensure that the pump is performing to specification. If the pump fails to reach the spec., contact your Ebara Service Center. (See "Service Centers".)



**Always set the overload to the rated motor current. The overload circuits allow for a 25% overcurrent.**

**Motor Current Specifications Chart (Amps)**

	Volts:	190	200	208	210	215	380	400	415	420
<b>50Hz</b>	<b>1.5kW</b>	8.8	8.8	8.8	8.8	9.0	4.4	4.4	4.4	4.4
	<b>2.2kW</b>	12.2	12.2	12.2	12.4	12.4	6.1	6.1	6.1	6.2
	<b>3.7kW</b>	19.4	19.4	19.6	19.6	20.0	9.7	9.7	9.8	9.8

	Volts:	190	200	208	210	215	220	230	380	400	415	420	440	460	480
<b>60Hz</b>	<b>1.5kW</b>	8.2	8.2	8.1	8.0	8.0	8.0	8.0	4.1	4.1	4.2	4.0	4.0	4.0	4.0
	<b>2.2kW</b>	11.2	11.2	11.0	11.0	11.0	10.8	11.0	5.6	5.6	5.5	5.5	5.4	5.5	5.5
	<b>3.7kW</b>	18.4	17.9	17.7	17.6	17.4	17.4	17.4	9.2	9.0	8.9	8.8	8.7	8.7	8.7

9. Turn the pump off.
  10. Open the inlet valve.
  11. Set the Auto/Manual switch to Auto (when applicable).
- The pump is ready for regular operation.

#### 4.4 Auto Mode

The pump operates in Auto Mode when the Auto/Manual switch is set to Auto. This gives control to an external source.

#### 4.5 Manual Operation

The pump operates in Manual Mode when the Auto/Manual switch is set to Manual. This allows the operator to operate the pump from the control panel.

## 5.0 Pump Maintenance

### 5.1 Safety Issues



Thoroughly purge the pump for at least 15 minutes to remove all toxic gases before opening the pump for any reason.



Allow the pump to cool before attempting any maintenance.



When changing or replenishing lubricating fluid, be sure to stop the pump and allow the pump to return to atmospheric pressure. Because the lubricating fluid reservoir is under vacuum, the pump can be severely damaged if the lubricating fluid port plug is removed while the pump is in operation, or not at atmosphere.



The descriptions and instructions included in this manual are for a typical pump installation. Documentation specific to this pump installation has been included in the Attachments section. This section is located at the back of this manual. Please refer to the Attachments section for installation-specific information.

### 5.2 Weekly Maintenance

It is important to check the following points at least once a week:

- a. Lubricating Fluid Level (between upper and lower lines on lubricating fluid sight glass).
- b. Lubricating Fluid Color.
- c. Excessive or Unusual Noise.
- d. Motor Running Current.



- e. Cooling Water Flow (pump modules and gas coolers).
- f. Nitrogen Flow.
- g. Nitrogen Pressure.
- h. Temperature Monitor (if equipped)

## 5.3 Other Periodic Maintenance

### 5.3.1 Lubricating Fluid Change

The lubricating fluid should be changed every six months or when discoloration is noticed, whichever occurs first. See “Refilling or Replacing the Lubricating Fluid”.

### 5.3.2 Complete Pump Overhaul

Depending on the process, a complete pump overhaul is recommended every 1-2 years as a means of ensuring trouble-free performance. During overhaul service, all bearings, labyrinth seal rings, and O-rings are replaced; coolers are cleaned or exchanged, and the pump internals are cleaned, wet bead finished and vacuum baked. The overhaul requires 1-2 weeks to complete, not including shipping to and from the service center. Exchange pumps are available upon request. Contact your Ebara representative for further details.

## 5.4 Lubricating Fluid Level



**It is very important that the lubricating fluid is maintained at the proper level. Failure to do so could result in severe damage to the pump.**



**When changing or replenishing lubricating fluid, be sure to stop the pump and allow the pump to return to atmospheric pressure. Because the lubricating fluid reservoir is under vacuum, the pump can be severely damaged if the lubricating fluid port plug is removed while the pump is in operation, or not at atmosphere.**



Before attempting to add any lubricating fluid into the pump, it is imperative that the secondary reservoirs are drained first. Failure to do so could result in lubricating fluid being forced into the vacuum area of the pump.

## **! NOTICE**

Recommended lubricating fluids for pumps are Krytox 1525, FOMBLIN Y-LVAC 25/6, Barrierta J100, or equivalent.

### **5.4.1 Checking the Lubricating Fluid Level**

With the pump operating, the lubricating fluid level in all sight glasses should be at or above the lower limit line and, no higher than the upper limit line.

With the pump off, the lubricating fluid level should be at or just above the upper limit line.

### **5.4.2 Sight Glass Locations**

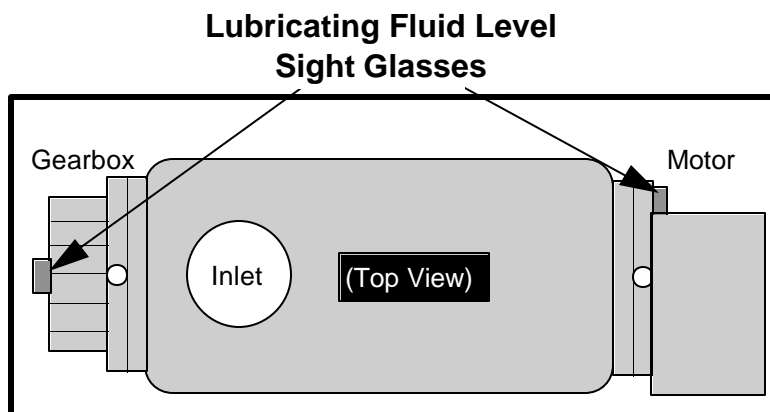

### **5.4.3 Checking for Discoloration**

If the color of the lubricating fluid is opaque or white, it has become contaminated with moisture. If the color of the lubricating fluid is brown or black, it may have become oxidized. If the color of the lubricating fluid has changed significantly from new, the lubricating fluid should be replaced.

### 5.4.4 Refilling or Replacing the Lubricating Fluid

**! DANGER**



Thoroughly purge the pump for at least 15 minutes to remove all toxic gases before opening the pump for any reason.

**! CAUTION**



Before attempting to add any lubricating fluid into the pump, it is imperative that the secondary reservoirs are drained first. Failure to do so could result in lubricating fluid being forced into the vacuum area of the pump.

**! CAUTION**



When changing or replenishing lubricating fluid, be sure to stop the pump and allow the pump to return to atmospheric pressure. Because the lubricating fluid reservoir is under vacuum, the pump can be severely damaged if the lubricating fluid port plug is removed while the pump is in operation, or not at atmosphere.

### 5.4.5 Changing the Lubricating Fluid

Lubricating Fluid Reservoir Fill / Drain Plugs

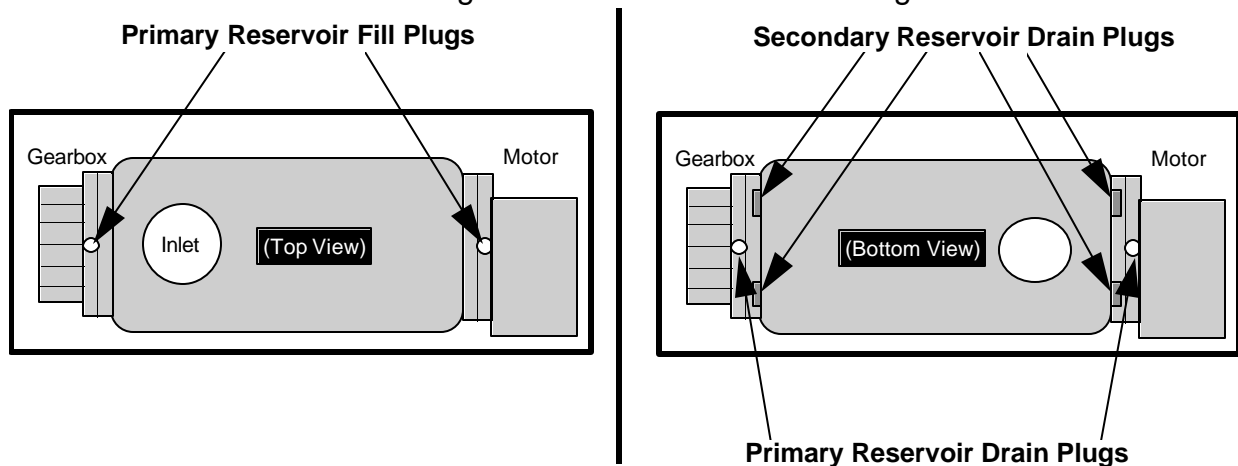

1. Stop the pump and allow the pressure in the pump to return to atmosphere.
2. Remove the lubricating fluid fill plug and place it on top of the pump.



**Be sure to use the outer most plugs. On all pump models, a second plug is located on the inner flange. This is not a fill plug and should not be removed to add lubricating fluid to the pump.**

3. Place at least a 1 liter or 1 quart capacity container below the drain plug for the secondary reservoir.
4. Remove the drain plug from the secondary reservoir. Allow the lubricating fluid to drain for several minutes to ensure sufficient drainage.
5. Check and clean the O-ring on the drain plug. Replace the O-ring if it is worn or damaged.
6. Replace and tighten the drain plug for the secondary reservoir.
7. Place the container for the used lubricating fluid under the drain plug for the primary reservoir.
8. Remove the drain plug from the primary reservoir. Allow the lubricating fluid to drain for several minutes to ensure sufficient drainage.
9. Check and clean the O-ring on the drain plug. Replace the O-ring if it is worn or damaged.
10. Replace and tighten the drain plug.
11. Remove the used lubricating fluid. Be sure to dispose of this lubricating fluid properly.

The pump is now ready for fresh lubricating fluid. At this point the sight glasses can be removed and cleaned if necessary. (See "Cleaning the Sight Glass".)

12. Pour the lubricating fluid into the fill port while viewing the level on the sight glass. Add lubricating fluid to slightly above the upper limit line.
13. Check and clean the O-ring on the fill plug. Replace the O-ring if it is worn or damaged.
14. Replace and tighten the lubricating fluid fill plug.

### 5.4.6 Replenishing the Lubricating Fluid

**! CAUTION**



**Before adding any additional lubricating fluid to the primary reservoirs, the secondary reservoirs must also be drained.**

1. Stop the pump and allow the pressure in the pump to return to atmosphere.
2. Remove the lubricating fluid fill plug and place it on top of the pump.

**! CAUTION**



**Be sure to use the outer most plugs. On all pump models, a second plug is located on the inner flange. This is not a fill plug and should not be removed to add lubricating fluid to the pump.**

3. Place at least a 1 liter or 1 quart capacity container below the drain plug for the secondary reservoir.
4. Remove the drain plug from the secondary reservoir. Allow the lubricating fluid to drain for several minutes to ensure sufficient drainage.
5. Check and clean the O-ring on the drain plug. Replace the O-ring if it is worn or damaged.
6. Replace and tighten the drain plug for the secondary reservoir.
7. Remove the used lubricating fluid. Be sure to dispose of this lubricating fluid properly.

The pump is now ready for fresh lubricating fluid.

8. Pour the lubricating fluid into the fill port while viewing the level on the sight glass. Add lubricating fluid to slightly above the upper limit line.
9. Check and clean the O-ring on the fill plug. Replace the O-ring if it is worn or damaged.
10. Replace and tighten the lubricating fluid fill plug.

### 5.4.7 Cleaning the Sight Glass

Should the sight glass become dirty, making it difficult to view the lubricating fluid level, the glass can be removed, cleaned, and reinstalled.

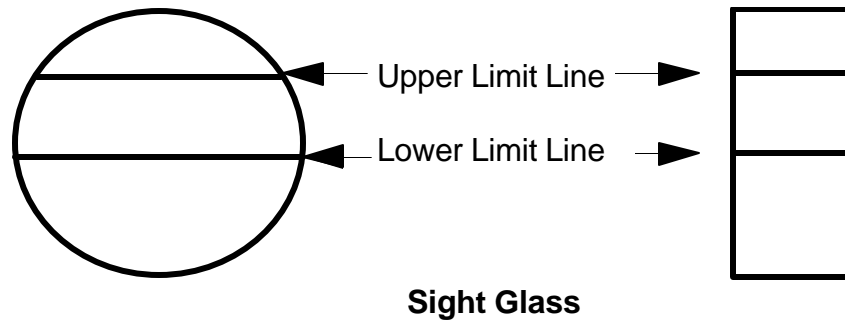
**Sight Glass****CAUTION**

**Before cleaning the sight glass, the pump must be at atmosphere, and the lubricating fluid must be drained. Failure to do so could cause severe damage to the pump.**

1. Remove the four screws securing the sight glass.
2. Remove the sight glass.

The sight glass can be cleaned with a clean lint-free wipe and alcohol.

3. Clean the O-ring and check for any damage. Replace the O-ring if it is worn or damaged.
4. Reposition the sight glass. Be sure the limit lines are on the out-facing surface and positioned properly (see the preceding diagram).
5. Reinstall the four screws. Be sure to tighten them evenly.

## 5.5 Vibrations and Noise

Early detection of unusual vibrations or noise reduces the possibility of serious damage. Careful observation on a regular basis will help to ensure long pump life. Initial operating levels serve as the basis for comparison.

Check for any unusual or excessive vibration or noise. If any abnormality is found:

1. Check that the pump is level.
2. Check the piping: fittings and support.
3. Check the lubricating fluid level of all gearboxes.
4. Check the motor current for proper operating level.
5. Check the exhaust check valve for proper operation.

## 5.6 Motor Current

With the pump running, check that the motor current is less than the rated value.



Always set the overload to the rated motor current. The overload circuits allow for a 25% over current.

### Rated Motor Current (Amps)

	Volts:	190	200	208	210	215	380	400	415	420
50Hz	1.5kW	8.8	8.8	8.8	8.8	9.0	4.4	4.4	4.4	4.4
	2.2kW	12.2	12.2	12.2	12.4	12.4	6.1	6.1	6.1	6.2
	3.7kW	19.4	19.4	19.6	19.6	20.0	9.7	9.7	9.8	9.8

	Volts:	190	200	208	210	215	220	230	380	400	415	420	440	460	480
60Hz	1.5kW	8.2	8.2	8.1	8.0	8.0	8.0	8.0	4.1	4.1	4.2	4.0	4.0	4.0	4.0
	2.2kW	11.2	11.2	11.0	11.0	11.0	10.8	11.0	5.6	5.6	5.5	5.5	5.4	5.4	5.5
	3.7kW	18.4	17.9	17.7	17.6	17.4	17.4	17.4	9.2	9.0	8.9	8.8	8.7	8.7	8.7

When the motor current goes above the rated value, or if the current is more than 10% above the value that was recorded at the start-up operation, it is possible that by-products are building up inside on one or all of the following: the pump casing, the gas coolers (if equipped), or the connecting pipe. It is also possible that the foreign substances have entered the pump. (For initial values, See “Start-Up & Trial Run”.)

The pump can run continuously until it reaches the rated current, even if the motor current is rising. Rising current usually indicates that the coolers (if equipped) or the exhaust line are becoming blocked and need to be cleaned.

## 5.7 Nitrogen Purge Flow

Check the purge meter and confirm that the flow is within  $\pm 10\%$  of the specified value. (See “40x20 Specifications”.)



The nitrogen purge rate has been adjusted at the factory to the required level, do not adjust the needle valves located at the purge ports.

### 5.7.1 Nitrogen Supply Requirements

(See “40x20 Specifications”.)

If the nitrogen purge rate is out of spec., check the following:

- The secondary pressure regulator. This may not be adjusted to the setting value: 1 kgf/cm<sup>2</sup>.
- The nitrogen flow meter valve. This must be fully open.
- Inlet tubing connections for the nitrogen purge are not securely tightened.

## 5.8 Cooling Water Flow Rate

Check the cooling water flow rate.

Flow meter location: The forward meter is for the pump and motor; the rear meter is for the gas coolers (if applicable). (See “40x20, Gear End”.)

If the flow rate is less than specified, then check the following:

1. Check the water valve(s) for adequate opening.
2. Check the inlet pressure; it may be low. Maximum and required differential pressure between inlet and outlet is 1.0-2.0 kgf/cm<sup>2</sup> (14 - 28 psi).
3. Cooling water piping may be clogged.
4. Check for water leaks.
5. Check the flow meter screen for obstruction.

### 5.8.1 Cooling Water Requirements

Flow: Motor and module:	5.0-8.0 lpm	1.3-2.1 gpm.
Gas coolers:	0.8-1.2 lpm	0.21-0.32 gpm.
Pressure (Operating)	1.0-2.0 kgf/cm <sup>2</sup>	14-28 psi.
Max:	2.0 kgf/cm <sup>2</sup>	28 psi.
Temperature (max)	30°C	86°F

## 5.9 Ultimate Pressure

The rated ultimate pressure is measured at the pump inlet with the Nitrogen purge on (at factory specifications).

- Confirm that the ultimate pressure is not above the rated value, or the value obtained at initial start-up. (For initial values, See “Start-Up & Trial Run”. For pump specifications, See “40x20 Specifications”.)

If the ultimate pressure is above the rated value, or above the value obtained at start-up, check for the following.

1. Leakage in the vacuum chamber or the connecting piping between the chamber and the pump, or both.
2. Improper adjustment of the Nitrogen flow needle valves.



## 5.10 Cooler Inspection and Cleaning



Respirators may be required when inspecting or cleaning coolers (Process dependent).



Wear protective gloves when performing maintenance on the coolers.



Protective eyewear should be worn when inspecting or cleaning coolers.



Allow the pump package to cool before attempting any maintenance. Wear protective gloves when performing maintenance on the coolers.

### 5.10.1 Overview

The following information is provided to help the end user become familiar with the coolers and to assist in making the required maintenance as easy and trouble-free as possible.

The Ebara multi-stage dry pump is equipped with "heat exchangers", or "inter-coolers" designed to keep the pump clean and to improve its performance.

These coolers are a maintenance item and must be cleaned periodically in order to provide a long life of clean, dry vacuum pumping.

The coolers have been designed to be removed, cleaned, and replaced with minimum downtime. They are made of high quality stainless steel to provide long life and to resist the harshest of processes. To minimize down time, maintaining a second set of coolers is advisable.

The coolers are designated by the stage of the pump that is entering the cooler. Coolers are designated as 3rd, 4th, and 5th stage.

On Single Pass coolers, the gas flow passes through tubes surrounded by a water jacket.

## Inspection

Solid matter gradually builds up on the inside of the gas coolers when the pump is run with process gases. The rate of build-up is dependent on the process and wafer throughput. Therefore, part of the maintenance of the pump includes periodically inspecting and cleaning the gas coolers.

Ebara recommends that all coolers used on process equipment be inspected after two to three months of use to determine the amount of process build-up. (See 'Cooler Inspection Procedure'). Since most processes are not identical, the time intervals and the amount of build-up between cooler cleanings will vary. Process build-up depends mostly upon process chemical content and the amount of usage. Once a rate of buildup is determined, subsequent cooler cleaning can be scheduled a convenient time so as not to interfere with production.

All coolers should be cleaned when process build-up in the coolers reaches 50%-60% full. If the cooler maintenance is ignored, the process build-up will clog the coolers, causing the pump to overheat, or causing process build-up inside the pump chambers. These factors will require premature pump overhaul or possibly replacement of the pump.

The following list summarizes the typical intervals between cooler cleanings for several common semiconductor processes. If not listed below, please contact the local Ebara service representative for assistance in determining the appropriate inspection and cleaning interval.

Process	Recommended Interval
Metal Etch	3 - 6 Months (a function of chemistry)
SiN (PECVD)	2 - 3 Months
SiN (LPCVD)	2 Months
TEOS /SiO <sub>2</sub>	Cooler Cleaning normally not required
Asher	Cooler Cleaning normally not Required.

## Cleaning

Cooler cleaning involves removing the coolers from the pump and soaking the coolers in water or weak acid solutions (depending on the process) to dissolve away any chemical deposits. Down-time can be minimized by having a set of exchange coolers available. Coolers can be removed and reinstalled in about 2-3 hours.

After soaking, the coolers need to be leak-checked using either a Helium leak test, Hydrostatic leak test using 10.5 kgf/cm<sup>2</sup> (150 psi pressure), or immersion in water with compressed air to the cooler tubes. After the soundness of the cooler tubes is confirmed, the coolers should be dried in an oven.

The following list summarizes the recommended cooler cleaning procedures for several common semiconductor processes. If not listed below, please contact the local Ebara service representative for assistance in determining the appropriate cleaning procedure.

Aluminum Etch Processes: Clean the coolers by soaking them in water for 2-3 hours.  
PECVD Processes: Cooler cleaning can be accomplished without removing the coolers from the pump. Remove both end caps from each cooler and remove the loose powdery chemical build-up using a vacuum cleaner.



**Wear protective gloves when performing maintenance on the coolers. Review safety precautions to be taken when using HF Acid before attempting to clean the coolers.**

Nitride LPCVD: For Nitride LPCVD service, the coolers should be examined after two months of service. Clean the coolers by dipping them briefly in a 5-10% solution of HF acid and then rinsing them in water. Continue this process until the process chemicals have been completely removed.

**The coolers can be damaged if they are left in the solution for any extended length of time.**

#### 5.10.2 Single Pass Cooler Inspection Procedure



**Respirators may be required when inspecting or cleaning coolers (Process dependent).**



**Wear protective gloves when performing maintenance on the coolers.**



**Protective eyewear should be worn when inspecting or cleaning coolers.**



**Allow the pump package to cool before attempting any maintenance. Wear protective gloves when performing maintenance on the coolers.**

Inspect the hot, or inlet side of cooler #3. This is the area that plugs first, and it can be used to determine the amount of deposits in the other coolers. If the #3 cooler shows heavy deposits, the other coolers should be inspected (and cleaned if necessary). If the #3 cooler shows little deposits, the others need not be inspected.

To determine the approximate amount of process build-up in the cooler tubes, use the following steps. This procedure takes approximately 2-3 hours to complete.

1. Shut off the pump and the Nitrogen flow; allow the pump to cool.



**Failure to shut off the Nitrogen flow could result in process gasses venting into the work area and causing injury to personnel. (It is NOT necessary to shut off the cooling water).**

2. Remove the clamps from NW 40 and NW 25 connections on the end caps.
3. One at a time, remove each end cap by removing 8 mm bolts (8 stainless steel bolts) with a 6 mm hex wrench.



**If any of the bolts are seized, apply WD-40, Liquid Wrench, LPS, or other penetrating product in liberal amounts while torquing the bolt back and forth. This will usually loosen the bolt and prevent twisting off the bolt head.**

4. Examine the cooler tubes to determine the approximate build-up by the amount of process adhering to the walls of the tubes.
5. Write down the % amount of build-up in the coolers. (Photocopy and use the Cooler Cleaning and Inspection Form).

Example: 30 - 40% build-up in the tube.

6. Examine the O-ring and replace it if necessary. (Part Description: G-90).
7. Replace the end cap being careful not to pinch or damage the O-ring. Replace the centering O-ring if necessary.
8. Apply graphite anti-seize (Permatex 133A) to each of the bolts to prevent galling or the transfer of metal.
9. Replace the stainless steel 8 mm bolts and tighten the bolts in an even criss-cross pattern or until the end cap is seated firmly against the cooler body.
10. Replace the end caps, one at a time, before proceeding to the next one to minimize the fumes and moist air from getting in and out of the pump.

Repeat the steps on each cooler for both sides. Document each side separately. (Each cooler has a hot gas side, which is gas exiting the pump, and a cold gas side, where gas exits the cooler). Include all piping between the pump and coolers and exhaust piping from coolers, including the check valve in the inspection.

11. Test the pump for leaks. (See “Leak-Checking the Pump”).

### 5.10.3 Single Pass Cooler Cleaning Procedure



**Respirators may be required when inspecting or cleaning coolers (Process dependent).**



**Wear protective gloves when performing maintenance on the coolers.**



**Protective eyewear should be worn when inspecting or cleaning coolers.**



**Allow the pump package to cool before attempting any maintenance. Wear protective gloves when performing maintenance on the coolers.**

This cooler cleaning procedure requires at least 6 hours of down-time to complete. If a spare set of coolers is available, the required down-time is reduced to 2-3 hours.

1. Turn off the pump and allow cooling water and Nitrogen to run approximately 15 minutes. This is to cool down the coolers, and to dilute any process gas that may still be trapped in the pump.
2. Mark the cooler bodies and end caps designating third, fourth, or fifth with an indelible ink pen.
3. After 15 minutes, turn off the Nitrogen. If removing the plumbing, disconnect the Nitrogen (swage lock) lines. (You will need a 9/16" wrench).

4. Remove the clamps on all NW 40 and NW 25 connections.
5. Remove U-bolts around the cooler bodies. (You will need a 13 mm wrench).
6. Shut off the cooling water supply. Open the two swage lock connections using a 11/16" wrench and drain the water out of the pump and coolers. Nitrogen can be used to aide in draining the water. (You will need a large, flat tray or pan).
7. Disconnect the remaining water lines and remove the coolers.

**! CAUTION**



**If possible, cap all disconnected lines to help prevent any contamination.**

**! DANGER**



**Do not remove the end caps. The remaining water inside the coolers will cause fumes if it comes in contact with process build-up.**

Prior to removing the piping, it is helpful to mark which side it was removed from, i.e., exhaust piping and inter-cooler piping in between the pump and coolers, check, valve, etc.

1. Remove all piping.
2. Seal off the openings in the bottom of the pump with duct tape to prevent moist air from getting inside the pump.
3. Transfer all parts to be cleaned to a sink with a vented hood; have the sink filled with water.
4. Check the end caps and bodies of coolers to determine if alignment markings are stamped on them, i.e.; U1, U2, or U3. If they are not marked, mark or scratch both bodies and end caps to ensure correct alignment during re-assembly of coolers.
5. Remove the end caps by removing eight - 8 mm bolts using a 6 mm hex wrench.

**! CAUTION**



**If any of the bolts are seized, apply WD-40, Liquid Wrench, LPS, or other penetrating product in liberal amounts while torquing the bolt back and forth. This will usually loosen the bolt and prevent twisting off the bolt head.**

6. Remove the O-ring and set it aside.
7. Write down the % amount of build-up in the coolers. (Photocopy and use the Cooler Cleaning and Inspection Form on page 44).
8. Soak the coolers, or rinse them off if necessary, until all process build-up is dissolved from the coolers.

**! NOTICE**

If a helium leak detector is not available, proceed to #9. If a helium leak detector is available, skip to #10 and continue through #15. After #15 perform a helium leak check.

9. Check all coolers for leaks by blanking or plugging off one water connection. Apply Nitrogen or compressed air at 5.3-7.0 kgf/cm<sup>2</sup> (75-100 psi) to the other water connection. Submerge cooler body under water and look for bubbles escaping. Repeat the rest on all cooler bodies. If the cooler leaks, DO NOT USE! Replace cooler.
10. Place all clean parts in an oven and bake at 190°C (375°F) for one half hour, or at 150°C for one hour, to get out all of the moisture. A vacuum is desirable, if equipment is available.

**! WARNING**

**Wait until all of the parts are cool and dry before starting to reassemble them.**

11. After the parts are dry and cool, locate and organize all parts. Look for matching marks on end caps and coolers.
12. Check all O-rings and replace them if necessary. (Ebara Part Number: G-90).
13. Reinstall end caps to cooler bodies ensuring that the markings line up. Be careful not to pinch the O-rings.
14. Use graphite anti-seize (Permatex 133-A) on stainless steel bolts before bolting the end cap to the cooler body.
15. Tighten the bolts evenly in a criss-cross pattern until the end cap is seated tightly against the cooler body.

**! NOTICE**

**Perform a helium leak check at this point. When finished continue to the next step.**

16. Use two 36" bungee cord tie-downs to support the coolers on the pump.
17. Connect all vacuum lines and reinstall all NW 40 and NW 25 connections and piping between the pump coolers.
18. Re-install the u-bolts.
19. Re-install all water line connections.
20. Re-install all Nitrogen connections.

**! CAUTION**

**Be careful to make a tight seal on the flanges. Replace worn or damaged O-rings.**

21. Reinstall piping for exhaust to 6th stage cooler.



**When installing the exhaust piping, be sure that the check valve is facing correctly. If installed incorrectly, dry pump will fail due to exhaust back pressure.**

22. Once the piping is reinstalled, turn on the cooling water flow and examine for leaks.

23. Test the pump for leaks. (See “Leak-Checking the Pump”).

### 5.10.4 Cooler Cleaning and Inspection Form

Company Name: \_\_\_\_\_ Location: \_\_\_\_\_  
 Pump Model: \_\_\_\_\_  
 Serial Number: \_\_\_\_\_  
 Configuration: \_\_\_\_\_  
 Process Type: \_\_\_\_\_  
 Services: \_\_\_\_\_  
 Inlet Gases: \_\_\_\_\_  
 Cooler Type -  
 Check (X) One:    Single Pass: \_\_\_\_\_                      U-Tube: \_\_\_\_\_

#### PROCESS BUILD-UP RECORD

Hot (Inlet) Side	Cold (Outlet) Side
3rd Stage (#1): _____%	3rd Stage (#1): _____%
4th Stage (#2): _____%	4th Stage (#2): _____%
5th Stage (#3): _____%	5th Stage (#3): _____%



## 5.11 Leak-Checking the Pump

Whenever any internal connections of the pump package are broken, it is important to minimize the potential for gross leaks. A leak into the pump package could allow moisture to react with process gasses. This could cause severe damage to the pump. A leak out of the pump could allow process gasses to escape into the fab, leading to potentially hazardous conditions. The following are only initial checks. Further checking may be necessary with a helium leak detector.

### 5.11.1 Leak Testing the Pump

When examination or cleaning of the coolers is complete, test the pump for leaks by following the listed steps.

Test No. 1

1. Turn off the Nitrogen.
2. Blank off the inlet of the pump with the appropriate blank flange with a vacuum gauge attached.
3. Start the pump and run it until the base pressure is reached.
4. With the pump running, place a collapsed latex glove tightly around the exhaust and watch for the glove to inflate. If the glove inflates, there is a leak. Find and fix the leak.

Test No. 2

1. With the pump off, blank off the inlet.
2. Attach a blank flange to the exhaust with a pressure gauge on it.
3. Allow a small amount of Nitrogen gas into the pump, approximately 1.1-1.4 kgf/cm<sup>2</sup> (15 - 20 psi).
4. Watch for the needle on the pressure gauge to go down. If it does, there is a leak. Find and fix the leak.

These simple leak tests are designed to identify leaks that are sometimes present after cleaning the coolers. These tests do not take the place of the standard leak against time test, or of a quality test, done with a Helium leak detector.

## 5.12 Consumables and Spares List

This is a general recommended Spares List for the UERR series Ebara Dry Pumps.

	Exhaust Check Valve* 980083	Motor Contactor* 2hp/208V 916031	Motor Contactor 3hp/208V 980754	Motor Contactor* 5hp/308V 989079	Lubricant  980595	Water Flow Switch* 980085	Cooler G-90 O-Ring 989169	Cooler G-140 O-Ring 923043
40x20	1	–	1	–	1	1	–	–
40x20 w/clrs	1	–	1	–	1	1	6	–
65x40 U-Tube	1	–	–	1	2	1	–	6
65x40 3" clrs	1	–	1	–	2	1	6	–
50x20	1	1	1	–	2	1	6	–
80x25 U-Tube	1	–	1	1	2	1	–	6
80x25 3" clrs	1	–	1	1	2	1	6	–

\*Not needed for each pump. Keeping 1 in stock for every 10 pumps is recommended.

## 6.0 Troubleshooting

### 6.1 Possible Problems / Suggested Solutions

Table 1:

Trouble	Possible Causes	Solutions
Pump has shut down, and the water failure light is on.	Cooling water flow rate is below 3-4 lpm. Possible blockage.	Check the inlet flow and pressure for proper settings. If necessary, increase cooling water flow rate to 5-8 lpm. Check the inlet screen at the bottom of the flow meter for blockage. Restart the pump.
Coolers are clean, but the pump will not restart, or starts and then stops due to overcurrent.	Exhaust valve stuck.  Pump tolerances clogged with particulate.  Exhaust is clogged.	Examine the exhaust check valve and clean if necessary, or replace the exhaust valve.  Remove material by vacuuming out the pump while manually rotating the rotor in reverse at the end cap.  Clean the exhaust line.  Reset the over-current switch and restart the pump.
Gear lubricating fluid is cloudy or opaque.	Lubricating fluid has become contaminated with water.	Change the lubricating fluid.
Gear lubricating fluid darkens the sight glass.	Nitrogen flow across the labyrinth seal is blocked.  Nitrogen flow is too high (>18 lpm) across the labyrinth seals, causing a venturi effect.	Check the Nitrogen pressure and flow across the seals.  Reduce the flow to <18 lpm.

Table 1:

Trouble	Possible Causes	Solutions
Lubricating fluid is found in the secondary reservoir.	<p>Nitrogen flow across the labyrinth seal is blocked.</p> <p>Pump was not turned off and vented to atmosphere before removing the lubricating fluid fill plug.</p>	<p>Check the Nitrogen pressure and flow across the seals.</p> <p>Drain the secondary reservoir.</p>
Lubricating fluid is found in the dry pump swept volume.	The lubricating fluid fill plug was opened while the pump was running.	Depending on the amount of lubricating fluid, the pump may have to be torn down and cleaned. Contact your Ebara representative.
Pump is causing excessive vibration.	<p>Pump is not level.</p> <p>Pump is not on rubber cushions.</p>	<p>Level the pump.</p> <p>Ensure that the pump is on the rubber cushions provided.</p>
Pump package has shut down, and the trouble light is on.	<p>Lubricating fluid level low.</p> <p>Cooler tubes restricted due to inadequate P/M, or MFC failure in the tool.</p> <p>Restricted exhaust possibly due to moisture in the house exhaust, or metal etch deposit.</p>	<p>Check lubricating fluid levels in each reservoir: refill if necessary.</p> <p>Open cooler bonnets and examine cooler tubes for flow restrictions and clear any restrictions; reset current trip switches inside the control panel; restart the pump.</p> <p>Check the exhaust line for flow restrictions; reset current trip switches inside the control panel; restart the pump.</p> <p>If the pump fails to restart after completing the above, contact the Ebara Service Center.</p>

Table 1:

Trouble	Possible Causes	Solutions
Pump rotates in the wrong direction.	Pump wiring to the main connection is backwards.	Reverse any two of the three power input wires from the main power supply on the terminal switch.
Motor amperage is rising.	Particulate or other foreign matter is closing tolerances.  Coolers and/or an exhaust line is blocked.	Inspect pump for particulate buildup or other blockage. If there is heavy particulate build. The pump should be rebuilt.  Clean out the coolers or the exhaust line or both.
Water found in the coolers.	Water leak in the coolers.  Water entering from the fab exhaust line.	Change the defective cooler.  Redesign the dry pump exhaust into the fab exhaust so that water is not sucked back into the dry pump exhaust.
	Chamber cleaning water dumped into the pump.	Evacuate the chamber with the load lock, or use a more complete wipe-down procedure.
Slight increase (0.2 kg/cm <sup>2</sup> ) in inlet pressure to the sublimator.	Chemical buildup in the sublimator.	Remove and clean the sublimator.

Contact the local Ebara service representative if any of the following problems arise:

- a. Pump shutdown due to motor overload.
- b. Extremely high motor running current.
- c. Excessive or unusual noise.
- d. Lubricating Fluid leakage.
- e. Loss of pump performance.

## 6.2 Service Centers

### 6.2.1 USA

#### **EASTERN REGION:**

##### **EBARA Technologies, Inc.**

One Parklawn Drive  
Bethel, CT 06801  
Phone: (203) 790-1080  
Fax: (203) 790-7404

#### **CENTRAL REGION:**

##### **Ebara Technologies, Inc.**

3019 Alvin DeVane Boulevard, Bldg. 3, Suite 350  
Austin, TX 78741  
Phone: (512) 389-3993  
Fax: (512) 389-3995

#### **WESTERN REGION:**

##### **EBARA Technologies, Inc.**

##### **Silicon Valley Operations**

323 Sinclair Frontage Road  
Milpitas, CA 95035  
Phone: (408) 934-2888  
Fax: (408) 934-2801

##### **EBARA Technologies, Inc.**

##### **Sacramento, CA**

51 Main Avenue  
Sacramento, CA 95838  
Phone: (916) 920-5451  
Fax: (916) 925-6654

## 6.2.2 EUROPE

### DEUTSCHLAND

**EBARA Germany GmbH**

**PRECISION MACHINERY GROUP**

DonaustraBe 7

D-63452 Hanau

Phone: 49-6181-1876-0

Fax: 49-6181-1876-40

### HOLLAND:

**EBARA Technologies, Incorporated**

Jarmuiden 44

D1046 AC

Amsterdam, The Netherlands

Phone: 31-20-6114345

Fax: 31-20 6114375

### SCOTLAND:

**EBARA Technologies, Incorporated**

3 Adam Square

Brucefield Industrial

Estate Livingston, West Lothian

EH 54 9DE United Kingdom

Phone: 44-1506-460232

Fax: 44-1506-460222

## 6.2.3 ASIA/PACIFIC RIM

### JAPAN:

Ebara Corporation

Nissei-Aroma Square bldg., 37-1 Kamata

5-Chome, Ota-Ku, Tokyo 144-8721 Japan

Phone: (03) 5714-6606

Fax: (03) 5714-6081

### TAIWAN:

**Taiwan EBARA Densani (TED)**

No. 7 Nan-Yuen 2nd Road,

Chungli Tao Yuen, Taiwan ROC

Phone: 03-4522181

Fax: 03-4522186

**EBARA Corporation Taipei Office**

Rm 1406A, Chia Hsin Bldg # 96, Sec 2, Chung Shang N. Road  
Taipei, 10499 Taiwan ROC  
Phone: 886+02-2560-1166  
Fax: 886+02-2560-1177

**SINGAPORE:**

**EBARA Engineering Singapore (EES)**

No 1 Tuas Link2  
Singapore 639550  
Phone: 65+862-3536  
Fax: 65+861-0589

**KOREA:**

**EBARA Precision Machinery Korea Inc.**

15 FL, Kangnam Bldg. 1321 Seocho-Dong  
Seocho-Ku, Seoul, Korea  
Phone: 02-581-6901~5  
Fax 02-581-4211



## 7.0 Attachments

One or more of the following items are included to cover areas specific to your pump. Please refer to these attachments for further, pump-specific information.

